



Electric tricycle user manual

EUtype-approvalnumber:e5*168/2013*00348*00

TypeJPUU12DZK-B





Preface

Thanks for choosing Jinpeng electric tricycle series.

This Owner's Manual contains information needed for vehicle's basic instruction, proper operation, maintenance and care. Proper use, storage and maintenance can reduce the failure of the vehicle, ensure your driving safety, maintain the best performance of the vehicle and extend the service life of the vehicle. Please always read the manual before using the vehicle to ensure your safety and obtain the maximum enjoyment.

Jinpeng continually seeks advancements in products and quality. Therefore, while this manual contains the most current product information available at the time of printing, there may be minor discrepancies between your vehicle and this manual.

When the vehicle is transferred, please hand over this manual to the new user. New users also need to understand vehicle-related knowledge

Note:

The standard accessories are used as a base for the explanations and illustrations in this manual. Therefore some items may not apply to every model.



Content

Preface	1
1-1 Company Introduction	4
2-1 Vehicle Overview	5
2-1-1 Cargo E-Tricycle Body Structure:	5
2-2 Speedometer & Handle Bar Instruction	6
2-2-1 Speedometer	6
2-2-2 Left & Right Handle Bar.....	7
2-3 Key & Electric Loc	8
2-4 Power - off switch	9
2-5 Brake System	10
2-5-1 Brake peda.....	10
2-6 Gearshift Lever	12
2-7 Charging Plug & Charger	13
2-7-1 Charging Plug	13
2-7-2 Charger	14
2-8 Rearview Mirror	14
2-9 Vehicle Nameplate & VIN	15
2-9-1 Vehicle nameplate	15
2-9-2 VIN	16
2-10 Battery installation	17
3-1-2 Start Vehicle	20
3-2 Precautions During Driving	20
3-2-1 Safety Driving Rules	20



3-2-2 Protection Device	22
3-2-3 Loading.....	2
3-2-4 Attachment	23
3-2-5 Accessories	23
4-1 Vehicle Maintenance & Repair	23
4-1-1 Motor 's & Reae Axle 's Maintenance	23
4-1-2 Controller' s Usage & Maintenance	25
4-1-3 Wheel & Tire's Maintenance	26
4-1-4 Battery 's Usage Maintenance	27
4-1-5 Charger use and maintenance	29
4-1-6 Inspection and adjustment of the brake	30
4-2. Troubleshooting	31
4-2-1 Maintenance Periodic Table	31
4-2-2 Common Breakdowns	33
4-3 Circuit Diagram.....	34



1-1 Company Introduction

Jiangsu Jinpeng Group Co.,Ltd is the largest manufacturer of electric tricycles in the world,specializing in the development, production and sales of all kinds of electric vehicles.Founded in 2004 and headquartered in Xuzhou,Jiangsu Province.It is a large modern high-tech private enterprise.At present,there are 11 production bases in Jiangsu,Hebei,Henan,Sichuan,Hubei and Tianjin.The national factory covers an area of more than 266.67 hectares,with an annual capacity of 3 million.At present, the company has more than 400 patented technologies,including more than 80 invention patents.It is a high-tech enterprise in Jiangsu Province.

“Jinpeng”electric vehicles,sales network throughout the country over 30 provinces.Our sales network consists of more than 20000 distributors in China,America,Germany,India,Indonesia,Philippines,Pakistan,South Africa and other areas. Especially in China,you can find“Jin Peng”in every city and town.The sale volume in domestic market has been NO.1 since 2008.There are more than six million of Jinpeng vehicles being used in the world.Meanwhile Jingpeng is the only one in this industry that sells over one million units of EV per year.

Looking to the future,the company will continue to uphold the corporate mission of "driving innovation to drive enterprise progress and create beautiful travel with technology",and provide high-quality electric vehicle products to consumers around the world.



2-1 Vehicle Overview

2-1-1 Cargo E-Tricycle Body Structure:



1. Front wheel
2. Front fork
3. Headlights
4. Turning light
5. function keys
6. mirror
7. Front Windshield
8. Roof
9. Rear Backrest
10. Rear Seat Armrest
11. Rear Wheel
12. Rear Axle
13. Rear Seat Cushion
14. Front Armrest
15. Front Backrest
16. Front Seat Cushion
17. windshield wiper



2-2 Speedometer&Handle Bar Instruction

2-2-1Speedometer

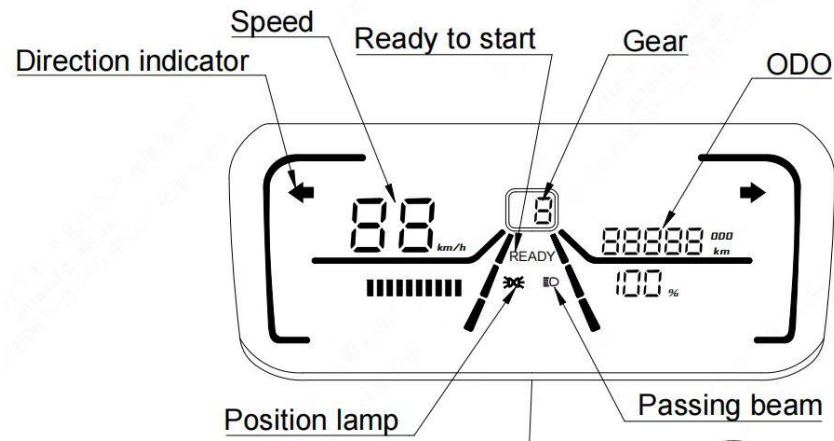

Figure 2-1 Speedometer

- 1 **【Direction indicator】** :The light fashes when you turn on lef signal or the light flashes when you turn on high beam signal.
- 2 **【High beam】** :The light flashes when you turn on right signal
- 3 **【Battery indicator】** :shows the remain battery power。
- 4 **【Odometer】** :I will show the mileage when you turn on the lock.
- 5 **【Speed signal】** :It will show you how many speed when you driving.

2-2-2 Left&Right Handle Bar

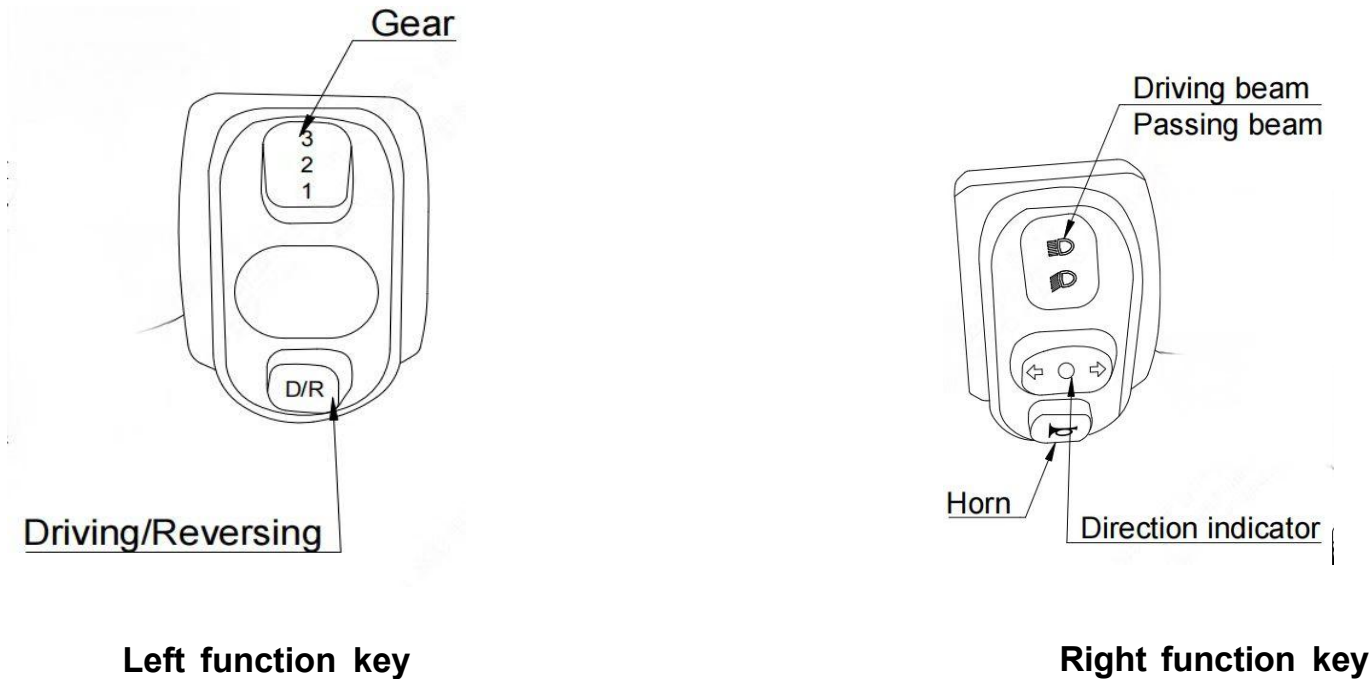

Figure 2-2 Throttle &Function

1 **【Throttle】** :Throttle is used to control the speed.When you want to accelerate,

2 **【control button】** :The “D”button is forward,The “R”button is backward,"3" is high speed,"2" is middle speed,"1" is low speed,all of these when you pressed the button



3 【Low beam &High beam】 The light ofthis modelectnictrcyce s open at alwaysOngh beam²O can let the road be more light at the dark space.

4 【Direction】 :“←”means turning left,” ”means turning right.

5 【Horn switch】 :“”, ”to remind and warn other people and vehicles.

6 【P switch】 :“  ” switch the button can be release parking status.

7 【Lef function key】 :Used to control the direction,please do not leave the grip with both hands at the same time

Notice:When stopped,please set the switch to “Neutral”,and remove the key to avoid misoperation by children or others, resulting in injury

When driving,please do not toggle the switch gear at will,and wait for the vehicle to stop completely before switching gears.

2-3 Key &Electric Lock

Insert the electric lock key into the lock hole and turn the key to "ON",the electric lock,turn the key to the "OFF",lock off
(The electrical lock position is shown in Figure 2-3 above)

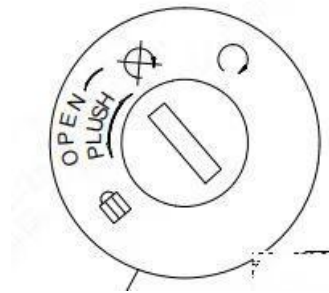

Figure 2-3 Electrical locks

2-4 Power-off switch

The power off switch is located in the inner side of the bucket bin, which is the on-off control switch of the whole vehicle power supply. When the vehicle is over-current or short-circuited, this switch will be automatically disconnected. When carrying out vehicle maintenance or suspension, manually disconnect the switch.

1 **【ON】** :At this position, the switch is in the path state.

2 **【OFF】** :In this position, the switch is in open state.



Figure 2-4 Power-off Switch

2-5 Brake System

2-5-1 Brake pedal

The brake pedal is located on the right front side of the pedal in the driving area, and the brake pedal is stepped down, and the vehicle brake system works.

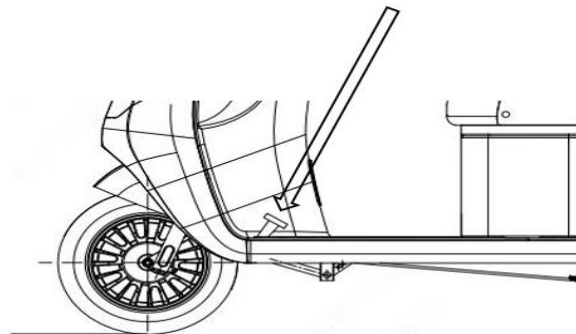

Figure 2-5 Brake pedal 1



2-5-2 Parking brakes

When you stop, you can avoid slipping by manipulating parking brakes, Turn off the power at the same time. Remove the parking brake before the vehicle starts.

With the parking brake shown in Figure 2-7, use as follows: **【Parking】** Pull up the parking brake as shown.

【release】 ① Press the lock release button, ② Put down the parking brake.

With the parking brake shown in Figure 2-6, use as follows:



【Parking】 1,Press the brake pedal2,Press handle 1 down to lock with pedal,release the pedal.

【Release】 Press brake pedal 2 to handle 1 to bounce naturally,at this time the parking brake is lifted.

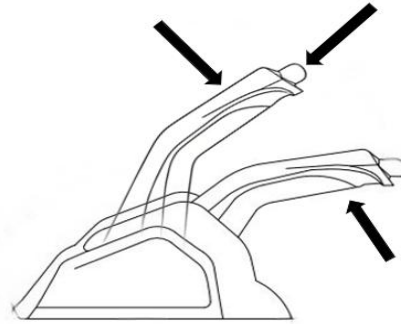

Figure 2-6 Parking brakes

2-6 Gearshift Lever

Some models are equipped with high and low speed gearboxes.High speed or low speed gear can be reasonably selected according to vehicle condition and road condition.

1 **【High Speed】** :The shifthandle is in the dotted line in Figure 2-8,the vehicle is in high speed,at this time the vehicle is faster.



2 【Low speed】:The variable speed button outputs different level signals to the vehicle controller as shown in Figure 2-7. The controller implements graded limiting on the motor drive current according to the preset program, so as to realize multi-speed adjustment and achieve the purpose of power mode switching and energy-saving control.

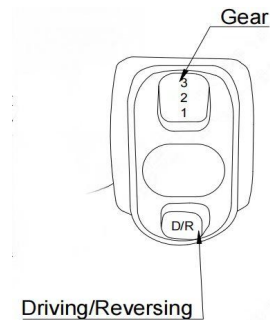

Figure 2-7 Variable speed button

2-7 Charging Plug &Charger

2-7-1 Charging Plug

The charging socket position is shown in figure 2-1. In the meter power display insufficient need to connect the charger to charge the battery. Charging time refer to charger instruction sheet.

When charging, please open the charging port protective cover and connect the charger. Please disconnect the power after charging and make sure the protective cover is closed.



Danger:It is forbidden to use conductive foreign body or finger to insert charging hole,
It is strictly forbidden to use water battery charger to charge the dry battery.
It is strictly forbidden to connect the charger for charging for a long time.

2-7-2 Charger

When charging with a charger,at one end of the plug ,220 V AC power supply is connected,and the other end is connected to the vehicle charging socket,and the connection of each joint is ensured to be well connected.When charging, the charger should be kept away from flammable materials and placed in a dry and ventilated place,do not put inside the seat barrel or other flammable surface (clothes,wood,etc.).

2-8 Rearview Mirror

The rear-vision mirror of the vehicle is a rotating adjustable rear-vision mirror,please adjust the rear-vision mirror angle to the right position according to the arrow direction in Figure 2-9 before driving to ensure your driving safety.

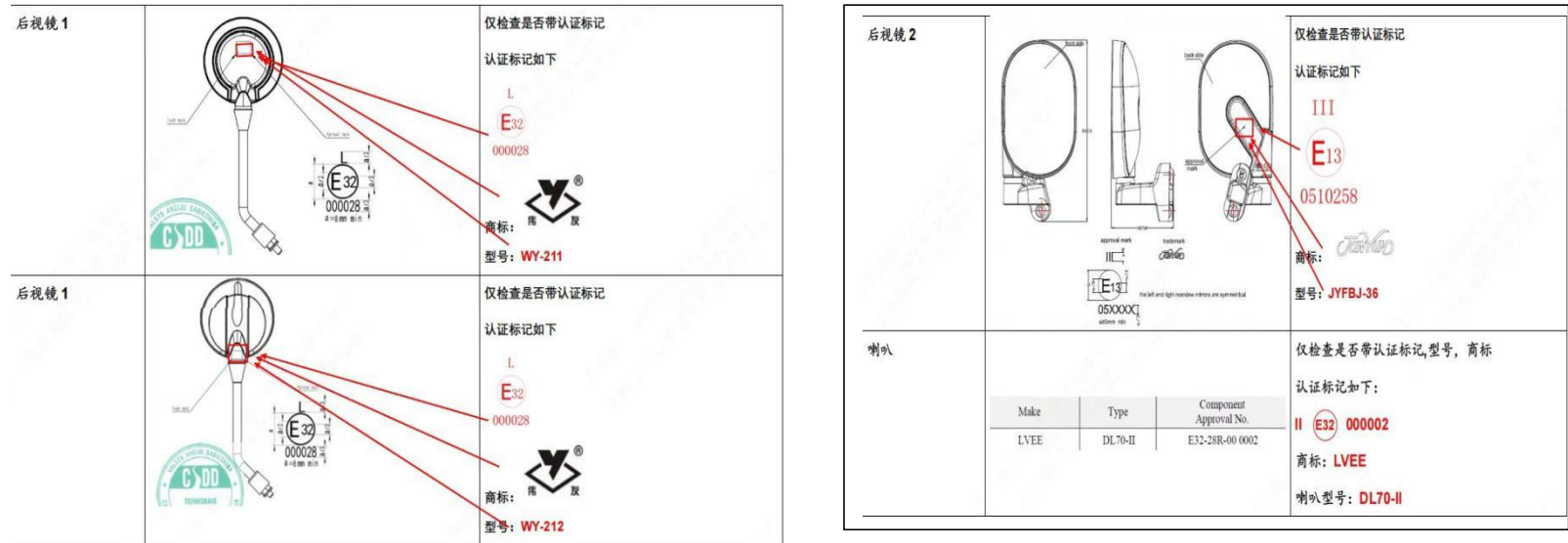
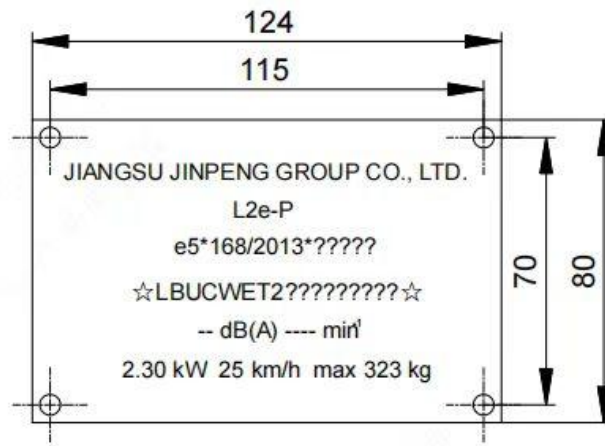

Figure 2-8 rear-vision mirror

2-9 Vehicle Nameplate &VIN

2-9-1 Vehicle nameplate

The nameplate is located on the right side of the seat,as shown in Figure 2-10.Product nameplate identifies the manufacturer of the vehicle,VIN code,product model,product name,date of production and the main parameters of the vehicle,which are non-detachable.The nameplate position may be adjusted due to different models.



Variant 00

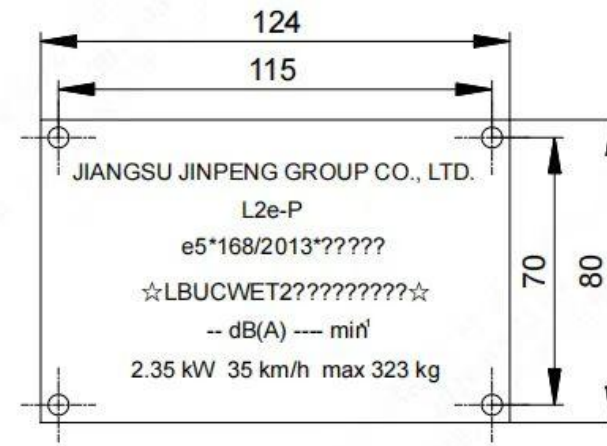

Variant 01

Figure 2-9 Label

2-9-2 VIN

Vehicle VIN code is the identification number of the vehicle,It contains information such as the manufacturer,year, model,body type and code of the vehicle.It has a unique identification of the vehicle.

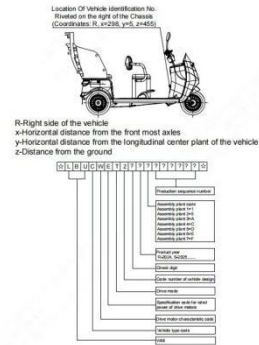
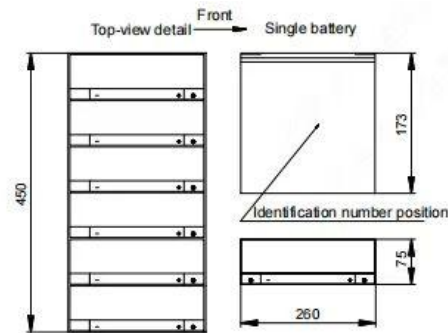

Figure 2-10 VIN code

The location of the VIN code:
 2-10 Battery installation



Manufacturer: Xupai International Trade Co., Ltd.
 Type: 6-DMF-32

Figure 2-11 Schematic diagram of battery pack wiring



Wiring scheme: Suitable for battery installation of 72V models.

Depending on the model, the car can be equipped with a variety of battery specifications. For the battery model and size, refer to the following table but not limited to the table below (size is for reference only)

Model	VoltageV	Weight/kg	Length/mm	Width/mm	Height/mm
6-EVF-20	12	6.1	180	76	170
6-EVF-32	12	9	266	78	170
6-EVF-38	12	10.5	223	108	175
6-EVF-45	12	12.2	223	120	175
6-EVF-52	12	13.5	223	135	177
6-EVF-58	12	16.5	230	151	180
6-EVF-80	12	23.5	259	170	210

Figure2-1 optional battery model



Warning:

- 1 When connecting the battery,make sure that the power switch is off;
- 2 The battery connection must be strictly in accordance with the diagram cross wiring is strictly prohibited;
- 3 It is strictly forbidden to run the battery cable from under the pressure plate;
- 4 After the water battery wiring is completed,please apply butter protection to the battery pole;
- 5 Must use the company's distribution or specified battery connection cable; 6When the battery is installed,it needs to be firmly fixed with the battery pressure plate.

3-1 Precautions before driving

3-1-1 Precautions before driving

It is necessary to conduct a safety check on the vehicle before driving,which will help drive safety and enjoy the fun of driving.

- 1 Tires (including spare tires):Check the tire pressure with a tire pressure gauge to ensure that the tire pressure is within the appropriate range,and check for cuts,damage,or excessive wear.
- 2 Tire nut:Confirm that no nut is missing or loose.
- 3 Vehicle tools:Confirm whether the tools are complete.



4 Instrument and control system:confirm whether the instrument and controller are normal,first turn on the power switch to confirm that the headlights,brake lights,driving lights,turn signals,reverse lights and other lighting are all working

5 Confirm whether the brake pedal has enough free clearance.

6 Make sure that the battery connection cable is not loose,damaged,or otherwise in poor contact.

3-1-2 Start Vehicle

1 Before starting the vehicle,check the surroundings of the vehicle.

2 Adjust the rearview mirror on the outside of the vehicle.

3 Close and fasten all compartment doors.

4 Insert the electric lock key and turn to [ON].

5 Remove the parking brake,gently turn the acceleration knob,and slowly start the vehicle.

3-2 Precautions During Driving

3-2-1 Safety Driving Rules

1 The vehicle driver must have certain driving experience.The first driving needs to be accompanied by a person with rich driving experience.It is not allowed to lend the vehicle to someone without driving experience.It is recommended that a



person with a C4 or above license drive the vehicle.

2 Vehicles should go to the designated place to register and obtain a driving license according to the requirements of the country or province and city. Unlicensed vehicles are not allowed to drive on the road. The driving license must be carried along with the vehicle during driving.

3 In order to prevent the vehicle from harming you or others, please pay special attention to the following safety matters

(1) Wear relatively brightly colored clothing.

(2) Maintain a safe driving distance from other motor vehicles, and use signal devices such as lights and horns correctly.

(3) It is strictly forbidden to occupy the road or drive on the road.

(4) Strictly abide by local traffic laws and regulations.

(5) Speeding is strictly prohibited, and the speed should not exceed the range permitted by local laws and regulations.

(6) Use turn signals correctly when turning or changing lanes to attract the attention of other drivers.

(7) Drive carefully at intersections, parking lot entrances and motorways.

(8) When the driver drives the vehicle, please strictly abide by the driver's operating regulations;

(9) Remember to drive on a rainy day: the braking distance is twice that of a sunny day. Under unknown road conditions,



high-speed driving is not allowed.

3-2-2 Protection Device

- 1 In order to ensure personal safety,you should not wear slippers when driving;when necessary,you should wear gloves, goggles,helmets and other protective equipment.
- 2 Loose clothes are not conducive to safe driving,and it is easy to hook the auxiliary equipment such as joystick,start lever and rearview mirror;

3-2-3 Loading

!warning

It is illegal to modify the vehicle or replace the original device at will,which cannot guarantee the driving safety of the vehicle. Users must abide by the traffic management department's regulations on the use of vehicles.

If the power supply or charging system fails,please contact our after-sales service department for repair or replacement.

If you have good suggestions for vehicle modification,you can write to our company and proceed with the consent,otherwise all consequences will be at your own risk.



3-2-4 Attachment

Adjust the tire pressure according to the weight of the load and the road conditions (the calibration pressure cannot be exceeded).

- Do not hang objects on the direction(disk),front fork,and rearview mirror to avoid unstable driving or slow steering
- It is strictly forbidden to overload passengers and goods.

3-2-5 Accessories

The accessories produced by our company have been specially designed and have been extensively tested on vehicles.

Since the company cannot test all other brand products,you are responsible for the selection,installation and use of non-comp any product accessories.Please follow the "Safe Driving Rules"and do the following:

- The loaded accessories must not obstruct the view,reduce the ground clearance or limit the control operation space,etc.
- Do not install electrical equipment,it may overload your vehicle's power,which may easily lead to disconnection of the circuit,causing the vehicle to not drive normally or lack of power.

4-1 Vehicle Maintenance &Repair

4-1-1 Motor's &Reae Axle's Maintenance



In order to ensure the normal operation of the vehicle, in addition to the requirements of special working conditions, the operation of fully opening the electric door for a long time should be avoided. Do regular inspections and motor maintenance. The interval of regular maintenance can be determined according to the form of the motor and the use environment. The contents of regular maintenance are as follows:

1. Clean the motor and remove the dust and sludge from the outside of the motor base in time.
2. Check and maintain the motor connection terminals, and check whether the connection box connection bolts are loose and clean.
3. Check the bolts of each fixed part, including pin bolts, end cover bolts, bearing cover bolts, etc., to ensure that the connection points are tightened effectively.
4. Inspection and maintenance of bearings, the bearings need to be replaced after a period of use. The time of cleaning and oil change should be determined according to the working conditions of the vehicle; generally every 3 to 6 months of work, the lubricant should be replaced.
5. After the new car travels 500km or 1 month, the rear axle should be replaced with lubricating oil, and the oil should be



changed every 1500km afterwards;after maintenance,the oil must be changed.When the amount of oil is insufficient,it should be refilled in time.

6.Oil change method

- ①Remove the vent plug at the top;
- ②Remove the oil drain plug at the bottom,drain the oil and reinstall the screw plug;
- ③Inject special gear oil from the vent plug port,the amount of refueling will vary depending on the model,please refer to the amount of refueling marked on the rear axle;
- ④Tighten the observation screw and vent plug.

4-1-2 Controller's Usage &Maintenance

The controller is a highly integrated electronic product,which is sensitive to static electricity,temperature,etc.Before each functional component and controller overhaul operation,remember to turn off the power before operating to avoid accidental loss;control during use Pay attention to ventilation and heat dissipation around the device,and prohibit overload operation.

The contents of regular maintenance are as follows:



- 1.Regularly clean the external dust of the controller,which is conducive to heat dissipation;
- 2.Regularly check the controller plug to prevent the controller from being invalid due to virtual connection;
- 3.After the controller is sprayed with water,clean the controller lead connector with clean water or alcohol in time to avoid oxidation and corrosion.

4-1-3 Wheel&Tire's Maintenance

The best adhesion of new tires can be demonstrated after 100KM,so it should be run in at an appropriate driving speed and driving mode to ensure driving safety and extend tire life.

Proper tire pressure can maintain the best driving stability,driving comfort,and tires are durable.The tire pressure should be checked frequently,and if necessary,the tire pressure can be adjusted within the tire calibration pressure.

Reference standard for tire pressure under cold conditions

Tire ressure(k Pa)	front tire:225±10	rear tire:250±10
--------------------	-------------------	------------------

Note:Before driving,check the tires for cuts,nails or other sharp objects embedded.Check whether the rim is dented or deformed.If you replace a damaged tire or a leaky inner tube,please contact your local service station.



! warning

1.Improper inflation of tires can cause abnormal tire damage,leading to safety accidents.Too low tire pressure will cause the tire to slip or falloff the rim,causing the tire to run flat and make the vehicle runaway.When the tread in the middle of the tire reaches the following limit value,please replace the tire (see Table 4-1)

2.After the end of the tire's life,you need to contact your local dealer to have it handled by a recycling station with qualified recycling qualifications.It cannot be discarded at will,causing environmental pollution;

Table 4-1 Minimum value of tread depth

Minimum value of tread depth(mm)			
front tire	1.6	rear tire	2.0

!warning
Using excessively worn tires is very dangerous and will ffect traction and safe driving of electric vehicles.

4-1-4 Battery's Usage Maintenance

The use and maintenance of the battery should strictly abide by the provisions in the battery manufacturer's manual.



To charge the battery, you must use the special charger that comes with the car. Charge in a well-ventilated environment. Fireworks should be strictly prohibited in the charging place.

! warning

1、 If you want to store the electric vehicle for a long time, you should remove the battery from the vehicle and fully charge it, then put it in a cool and dry place, and then recharge it every other month. The battery will release explosive gas and should be kept away from fire. When charging the battery or using the battery, keep it well ventilated.

2、 After the battery life is over, you need to contact your local dealer to hand it over to a recycling station that has the qualification to recycle used batteries. Users should not discard it at will to avoid environmental pollution;

Note: When installing the battery, make sure that the battery vent pipe is unobstructed. When washing the car, avoid water immersion around the battery.

The fuse is located near the battery, and its conventional rated current is 30A-50A (the actual model shall prevail). If the fuse blows frequently, it means that there is a short circuit or overload in the electrical system. Please contact our service station for repair.

note:



- The replacement fuse must comply with the regulations, and other conductive materials must not be used to replace the fuse, otherwise it will cause the electric vehicle to catch fire and the consequences will be at your own risk.
- When checking or replacing fuses, turn off the power switch first to avoid short circuit.

4-1-5 Charger use and maintenance

The correct use of the charger not only affects the reliability and service life of the charger itself, but also affects the battery life. When using the charger to charge the battery, please plug in the output plug of the charger first, then plug in the input plug. When charging, the power indicator of the charger is red, and the charging indicator is also red. When fully charged, the charging indicator is green. When stopping charging, please unplug the input plug of the charger first, and then unplug the output plug of the charger. Generally, over-discharging and over-charging the battery is harmful. Therefore, charge frequently, not overcharge.

There is a certain temperature rise when the charger is working. Please pay attention to ventilation and heat dissipation. The charging time is usually 8-10 hours, depending on the battery usage.

Chargers belong to sophisticated electronic equipment, therefore, it should pay attention to anti-vibration. Try not to



carry it with the car.If you really want to carry t,you should pack the charger with shock-absorbing materials and place it in the tool box on the car.

4-1-6 Inspection and adjustment of the brake

Good braking performance is an important guarantee for your driving safety.

The new vehicle brake system is all adjusted.However due to the wear of the brake pads,the loosening of the screws or other bad driving habits,it will cause extended braking distance or even brake failure.Under normal driving conditions,Pls check the degree of wear and thickness of the brake shoes,whether the degree of wear on both sides is balanced,whether the return is free,etc.per 2000km,if any abnormal situation is found,it shall be dealt with immediately.

When it is found that the braking distance is extended and the brake pads are lightly worn,the brake system can be simply adjusted as follows:

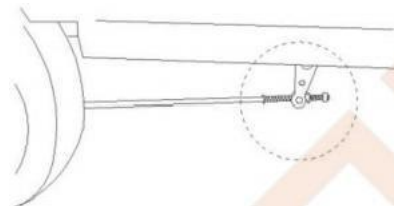

PIC4-1 brake adjusting nut



1 Turn the brake adjusting nut clockwise or counterclockwise to adjust the free stroke to the requirements.(The dotted line in Pic 4-1)

2 After adjusting the free travel, lift the rear wheel on one side or push the vehicle. There should be no resistance to the wheel turning.

3 Step on the brake pedal tightly, the brake pedal should have sufficient working space, the wheels can be braked or the vehicle cannot be pushed.

4-2. Troubleshooting

4-2-1 Maintenance Periodic Table

Maintenance cycle Maintenance projects		project cycle	Odometer (km)				
			1000	2000	4000	8000	12000
	control system		I	I	I	I	I
△	braking device		I	I	I	I	I
△	Battery	monthly	I	I	I	I	I
*	Fork steering bearing			I	I	I	I
△	braking light switch		I	I	I	I	I
△	Tires, rims		I	I	I	I	I
	Nuts&bolts fastener		I	I	I	I	I
△	Electrical appliances and lamps		I	I	I	I	I



Note: The meanings of various symbols in the table are as follows:

I: Inspect, clean, adjust, lubricate or replace.

C: Cleaning。 R: Replacement。 *: It should be serviced by professional when repaired

△: It is carried out by professional maintenance personnel, if the user has the maintenance ability, he can also maintain it by himself. When the odometer exceeds the highest number in the table, its maintenance cycle is still repeated according to the mileage interval specified in the table. !

WARNING ! The company will not bear any loss and responsibility if the maintenance or inspection is not carried out according to the requirements and the components are damaged or the car burns.



4-2-2 Common Breakdowns

No.	Fault	fault cause	elimination methods
1	Throttle disable or tope speed is low	(1)low battery voltage; (2)loosen of the wire in throttle; (3)spring stuck in throttle may failed.	(1)Charge the battery fully; (2)reweld; (3)clean or replace the throttle.
2	Motor does not work with power on	(1)the controller is protected due to the low voltage; (2)loosen of the wire in throttle; (3)motor hub connection plug loose or damaged.	(1)Charge the battery fully; (2)reweld; (3)call for professional or repair shop
3	Insufficient mileage for a single charge	(1)low tire pressure; (2)insufficient charging or charger failure; (3)ageing of battery.	(1)inflate the tire; (2)full charge or check the charger plug; (3)replace the battery.
4	Charger not charged	(1)charger socket off or plug losse; (2)charger fuse blew out; (3)the battery wiring off.	(1)tighten the socket and connector; (2)replace the same type of fuse; (3>welding the wiring.
5	Hard to ride and slow speed	(1)check if the brakes are blocked; (2)check the tire pressure; (3)battery low voltage; (4)lose oil in front and rear axles,or the shaft is too tight to flex	(1)adjust the brake; (2)inflate the tire; (3)charge the battery; (4)clean with grease.
6	Noise during the ride	(1)screws and nets are loose; (2)wheels touching fork and frame; (3)chain wheel or chain grinding cover. (4)ball wear or breakage in axles.	(1)tighten loose screws and nuts; (2)adjust the wheels; (3)adjust the wheel cover; (4)replace the balls.
7	Other faults	When you find faults you can't solve or not mentioned above	Call the distributor or repair shop



4-3 Circuit Diagram

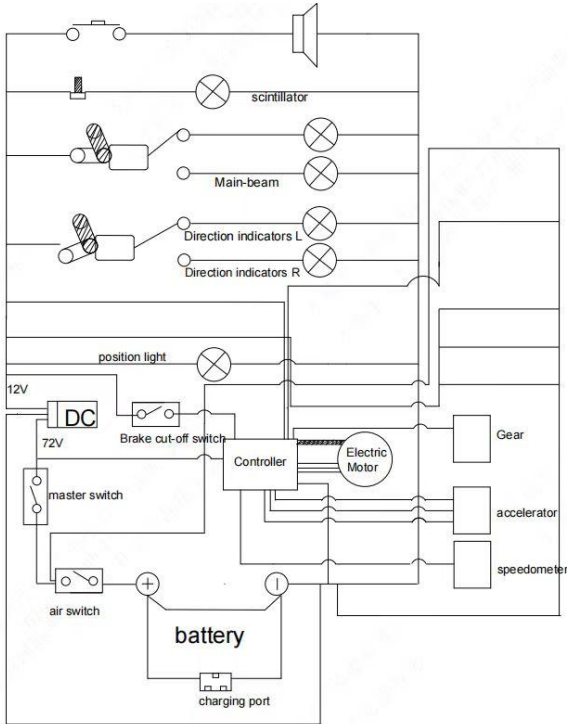

Vehicle route map

Remarks: This circuit diagram is a connection diagram, but not as a basis for maintenance. Please go to the designated after-sales service point if you need repair.



JINPENG GROUP
JINSHUN IMPORT AND EXPORT XUZHOU CO.,LTD